

# Combination Flashings

Keylite Flashing Kits are the most efficient way to ensure a watertight installation for your windows and have been designed to integrate efficiently with specific roofing materials.

## Grid System Flashing Components

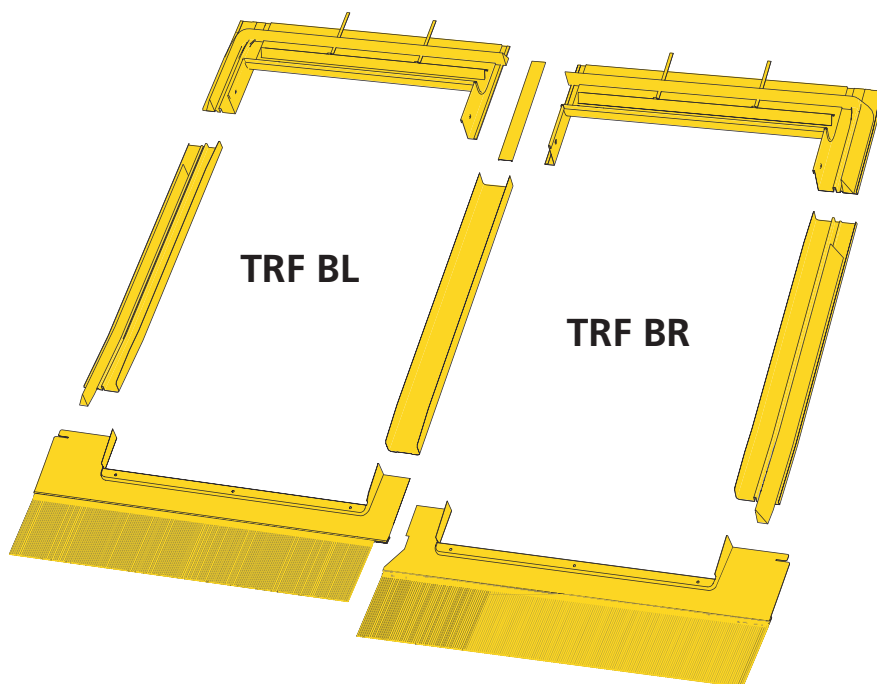

### Key

■ TRF

### How to Order

#### 12 Windows

1x TRF BL  
1x TRF BR  
2x TRF BM  
2x TRF TL  
2x TRF TR  
4x TRF TM



#### 6 Windows

1x TRF BL  
1x TRF BM  
1x TRF BR  
1x TRF TL  
1x TRF TM  
1x TRF TR



#### 4 Windows

1x TRF BL  
1x TRF BR  
1x TRF TL  
1x TRF TR



For any other arrangement of windows please contact the Keylite technical team.

### Tile: TRF

- ▶ **Roof Pitch 15° – 90°**
- ▶ **Material Profile – Max 90mm**  
Flashing for single window installation into flat or profiled interlocking tiles. Also suitable for interlocking slate and profiled sheeting.

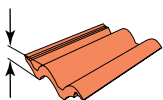

### Slate: SRF

- ▶ **Roof Pitch 15° – 90°**
- ▶ **Material Profile – Max 10mm**  
Flashing for single window installation into slate up to 10mm thick.  
**Not to be used with interlocking slate.**

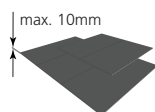

### Guarantee

- ▶ **10 Years** - Keylite's hassle free guarantee Flashings.

### Finish Options

- ▶ Grey
- ▶ Conservation Black (CW)

### GB

Unit 3 Gateway Road, Burton Gateway,  
Burton upon Trent, DE13 8FL

T: +44 (0) 28 8676 7512  
E: technicalsupport@keylite.co.uk

### NI & ROI

KG2, Ballyreagh Industrial Est. Sandholes  
Road, Cookstown, Co. Tyrone, BT80 9DG

# Combination Flashings

Keylite Flashing Kits are the most efficient way to ensure a watertight installation for your windows and have been designed to integrate efficiently with specific roofing materials.

## Combination Flashing Components

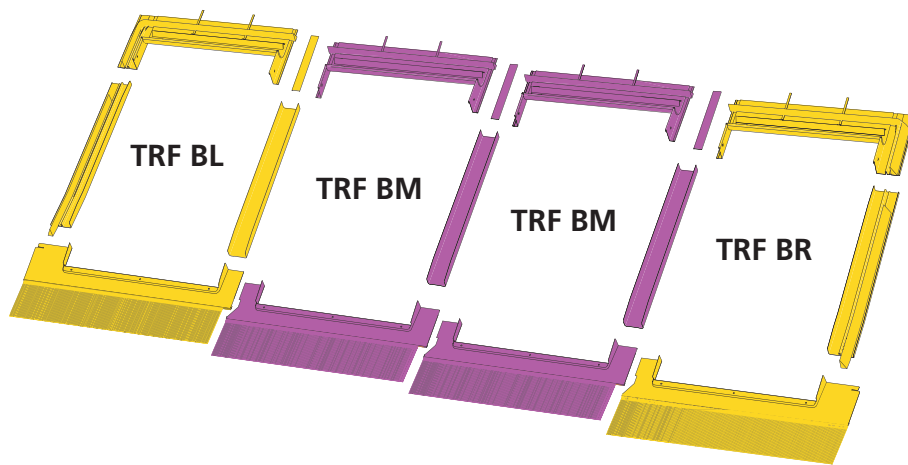

### Key

- TRF
- TRF BM

### How to Order

#### 12 Windows

- 1x TRF BL
- 1x TRF BR
- 2x TRF BM
- 2x TRF TL
- 2x TRF TR
- 4x TRF TM



#### 6 Windows

- 1x TRF BL
- 1x TRF BM
- 1x TRF BR
- 1x TRF TL
- 1x TRF TM
- 1x TRF TR



#### 4 Windows

- 1x TRF BL
- 1x TRF BR
- 1x TRF TL
- 1x TRF TR



For any other arrangement of windows please contact the Keylite technical team.

### Tile: TRF

- ▶ **Roof Pitch 15° – 90°**
- ▶ **Material Profile – Max 90mm**  
Flashing for single window installation into flat or profiled interlocking tiles. Also suitable for interlocking slate and profiled sheeting.

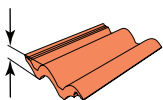

### Slate: SRF

- ▶ **Roof Pitch 15° – 90°**
- ▶ **Material Profile – Max 10mm**  
Flashing for single window installation into slate up to 10mm thick. **Not to be used with interlocking slate.**

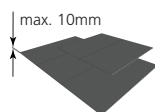

### Guarantee

- ▶ **10 Years** - Keylite's hassle free guarantee Flashings.

### Finish Options

- ▶ Grey
- ▶ Conservation Black (CW)

### GB

Unit 3 Gateway Road, Burton Gateway,  
Burton upon Trent, DE13 8FL

T: +44 (0) 28 8676 7512  
E: technicalsupport@keylite.co.uk

### NI & ROI

KG2, Ballyreagh Industrial Est. Sandholes  
Road, Cookstown, Co. Tyrone, BT80 9DG

# Combination Flashings

Keylite Flashing Kits are the most efficient way to ensure a watertight installation for your windows and have been designed to integrate efficiently with specific roofing materials.

## Combination Flashing Components

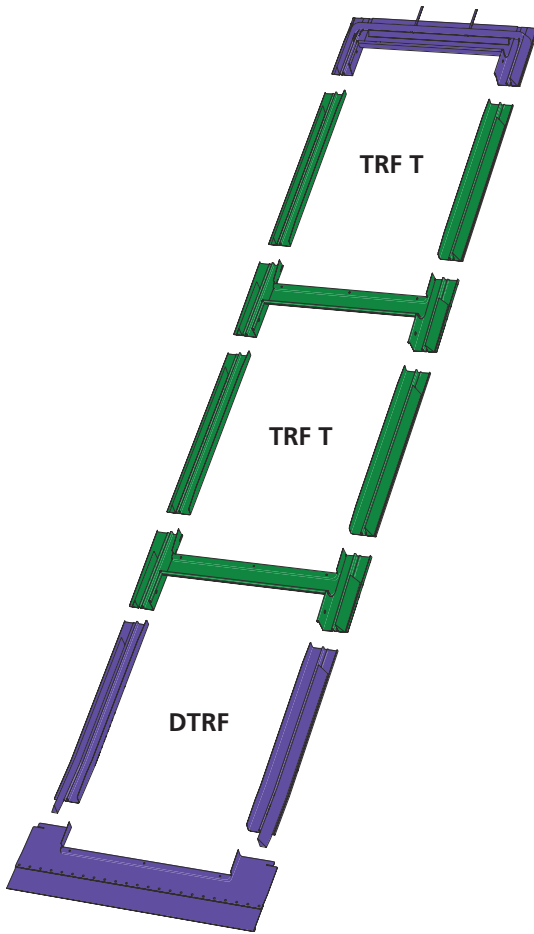

### Key

- DTRF
- TRF T

### How to Order

#### 12 Windows

- 1x TRF BL
- 1x TRF BR
- 2x TRF BM
- 2x TRF TL
- 2x TRF TR
- 4x TRF TM



#### 6 Windows

- 1x TRF BL
- 1x TRF BM
- 1x TRF BR
- 1x TRF TL
- 1x TRF TM
- 1x TRF TR



#### 4 Windows

- 1x TRF BL
- 1x TRF BR
- 1x TRF TL
- 1x TRF TR



For any other arrangement of windows please contact the Keylite technical team.

### Tile: TRF

- ▶ **Roof Pitch 15° – 90°**
- ▶ **Material Profile – Max 90mm**  
Flashing for single window installation into flat or profiled interlocking tiles. Also suitable for interlocking slate and profiled sheeting.

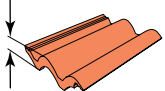

### Slate: SRF

- ▶ **Roof Pitch 15° – 90°**
- ▶ **Material Profile – Max 10mm**  
Flashing for single window installation into slate up to 10mm thick. **Not to be used with interlocking slate.**

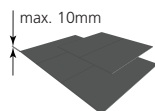

### Guarantee

- ▶ **10 Years** - Keylite's hassle free guarantee Flashings.

### Finish Options

- ▶ Grey
- ▶ Conservation Black (CW)

### GB

Unit 3 Gateway Road, Burton Gateway,  
Burton upon Trent, DE13 8FL

T: +44 (0) 28 8676 7512  
E: technicalsupport@keylite.co.uk

### NI & ROI

KG2, Ballyreagh Industrial Est. Sandholes  
Road, Cookstown, Co. Tyrone, BT80 9DG

# Combination Flashings

Keylite Flashing Kits are the most efficient way to ensure a watertight installation for your windows and have been designed to integrate efficiently with specific roofing materials.

## Combination Flashing Components

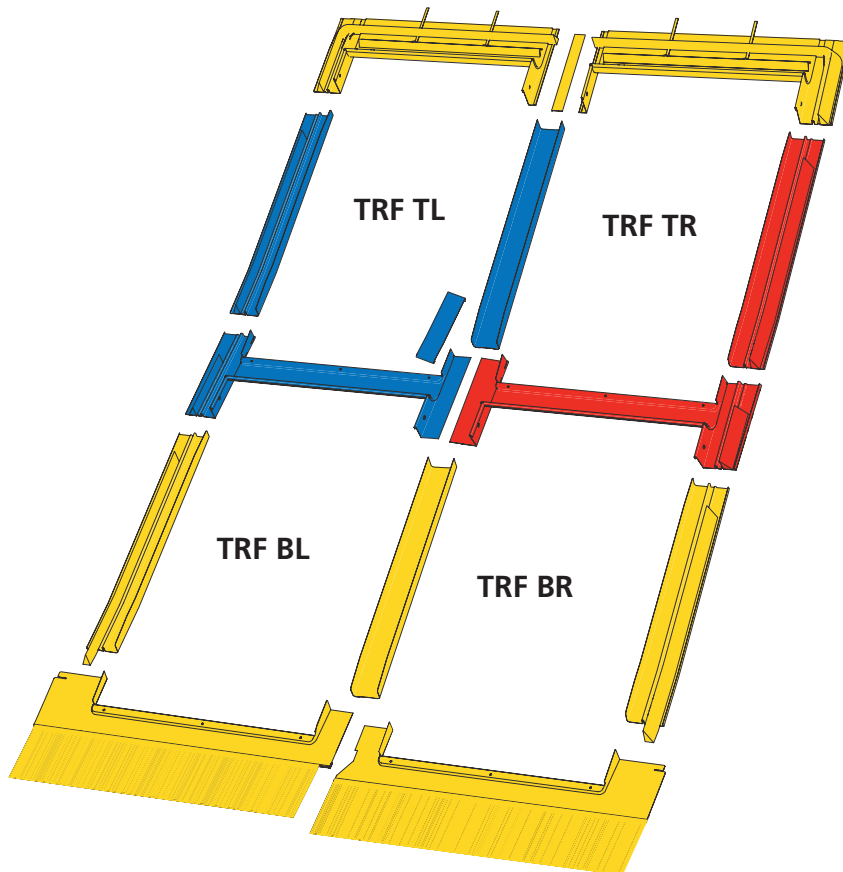

### Key

- TRF
- TRF TL
- TRF TR

### How to Order

#### 12 Windows

- 1x TRF BL
- 1x TRF BR
- 2x TRF BM
- 2x TRF TL
- 2x TRF TR
- 4x TRF TM



#### 6 Windows

- 1x TRF BL
- 1x TRF BM
- 1x TRF BR
- 1x TRF TL
- 1x TRF TM
- 1x TRF TR



#### 4 Windows

- 1x TRF BL
- 1x TRF BR
- 1x TRF TL
- 1x TRF TR



For any other arrangement of windows please contact the Keylite technical team.

### Tile: TRF

- ▶ **Roof Pitch 15° – 90°**
- ▶ **Material Profile – Max 90mm**  
Flashing for single window installation into flat or profiled interlocking tiles. Also suitable for interlocking slate and profiled sheeting.

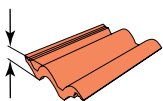

### Slate: SRF

- ▶ **Roof Pitch 15° – 90°**
- ▶ **Material Profile – Max 10mm**  
Flashing for single window installation into slate up to 10mm thick. **Not to be used with interlocking slate.**

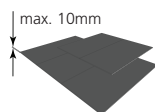

### Guarantee

- ▶ **10 Years** - Keylite's hassle free guarantee Flashings.

### Finish Options

- ▶ Grey
- ▶ Conservation Black (CW)

### GB

Unit 3 Gateway Road, Burton Gateway,  
Burton upon Trent, DE13 8FL

T: +44 (0) 28 8676 7512  
E: technicalsupport@keylite.co.uk

### NI & ROI

KG2, Ballyreagh Industrial Est. Sandholes  
Road, Cookstown, Co. Tyrone, BT80 9DG

# Combination Flashings

Keylite Flashing Kits are the most efficient way to ensure a watertight installation for your windows and have been designed to integrate efficiently with specific roofing materials.

## Combination Flashing Components

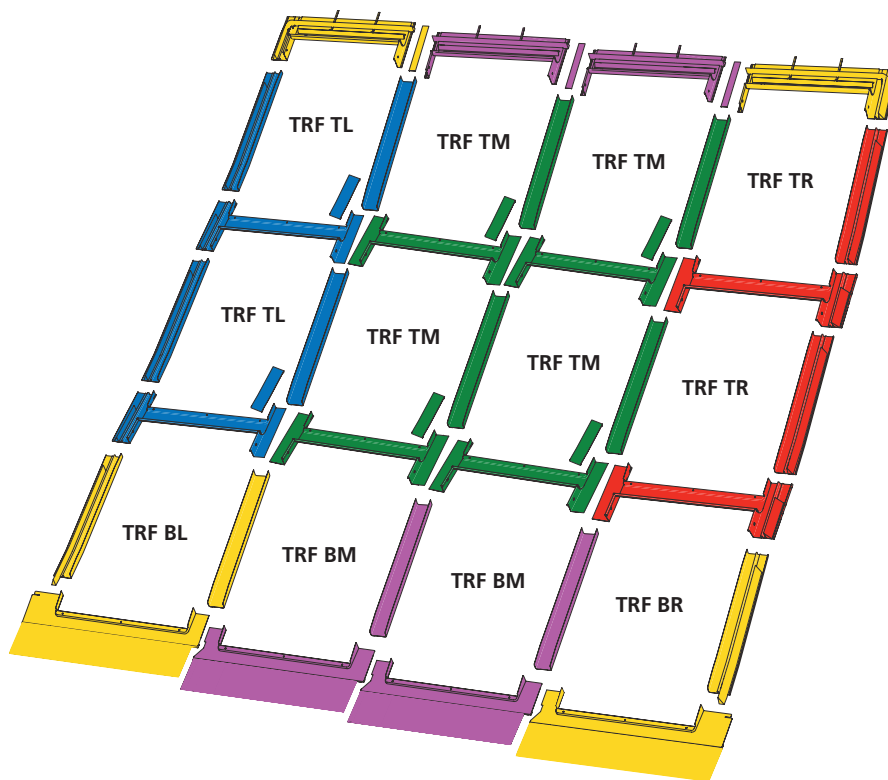

### Key

- TRF
- TRF BM
- TRF TL
- TRF TR
- TRF TM

### How to Order

#### 12 Windows

- 1x TRF BL
- 1x TRF BR
- 2x TRF BM
- 2x TRF TL
- 2x TRF TR
- 4x TRF TM



#### 6 Windows

- 1x TRF BL
- 1x TRF BM
- 1x TRF BR
- 1x TRF TL
- 1x TRF TM
- 1x TRF TR



#### 4 Windows

- 1x TRF BL
- 1x TRF BR
- 1x TRF TL
- 1x TRF TR



For any other arrangement of windows please contact the Keylite technical team.

### Tile: TRF

- ▶ **Roof Pitch 15° – 90°**
- ▶ **Material Profile – Max 90mm**  
Flashing for single window installation into flat or profiled interlocking tiles. Also suitable for interlocking slate and profiled sheeting.

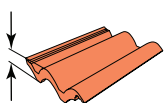

### Slate: SRF

- ▶ **Roof Pitch 15° – 90°**
- ▶ **Material Profile – Max 10mm**  
Flashing for single window installation into slate up to 10mm thick.  
**Not to be used with interlocking slate.**

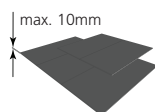

### Guarantee

- ▶ **10 Years** - Keylite's hassle free guarantee Flashings.

### Finish Options

- ▶ Grey
- ▶ Conservation Black (CW)

### GB

Unit 3 Gateway Road, Burton Gateway,  
Burton upon Trent, DE13 8FL

T: +44 (0) 28 8676 7512  
E: technicalsupport@keylite.co.uk

### NI & ROI

KG2, Ballyreagh Industrial Est. Sandholes  
Road, Cookstown, Co. Tyrone, BT80 9DG